

the qyooo

VST™ Polyphonic Synthesizer

Version 1.0

© 2016-2017 by Björn Arlt @ Full Bucket Music
<https://www.fullbucket.de/music>

Additional Presets by Krezie Sounds
<http://www.kreziesounds.com/>

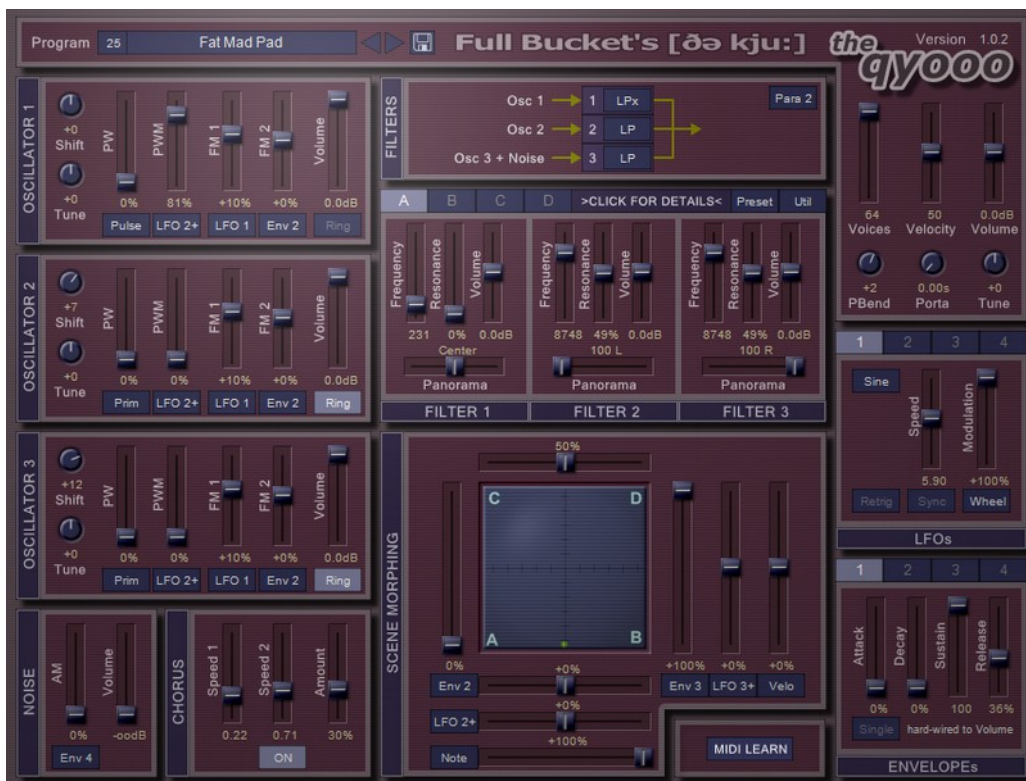

VST is a trademark of Steinberg Media Technologies GmbH

Table of Contents

Introduction.....	3
Architecture.....	3
Filter Bank.....	4
Scene Morphing.....	5
Scene Editing.....	6
Scene Menus.....	7
Parameter Context Menu.....	7
Chorus.....	7
Modulation Sources.....	8
LFO and Envelopes.....	8
Performance Controls.....	9
Program Menu.....	9
MIDI Learn.....	9
Options Menu.....	9
The qyooo.ini Configuration File.....	11
Skinning Support.....	11
MIDI Control Change Messages.....	11
Parameters.....	12
Global.....	12
Oscillator 1.....	12
Oscillator 2.....	12
Oscillator 3.....	12
Noise.....	13
Filter Bank.....	13
Scene Morphing.....	13
Scene A.....	14
Scene B.....	14
Scene C.....	14
Scene D.....	14
LFO 1.....	14
LFO 2.....	14
LFO 3.....	15
LFO 4.....	15
Envelope 1.....	15
Envelope 2.....	15
Envelope 3.....	15
Envelope 4.....	15
Chorus.....	15
Frequently Asked Questions.....	16

Introduction

The *qyooo* (pronounced "the Q") is a VST™2.4 software synthesizer for Microsoft® Windows®. It is written in native C++ code for high performance and low CPU consumption. The main features are:

- Three zero-delay feedback filters with different modes and arrangements
- Complex *Scene Morphing* section for filter modulation
- Three band-limited oscillators including Ring modulation
- Additional White Noise generator
- Four LFOs and envelopes
- Up to 64 voices polyphony including Portamento
- Chorus effect
- MIDI Learn – all parameters can be controlled by MIDI CC
- Double precision audio processing
- Plug-in comes in 32 bit and 64 bit versions
- Fully compatible with SM Pro Audio's V-Machine™

The great 25 presets from #26 (*Iron Sky*) to #50 (*Woodophone*) are created by Krezie Sounds – big thanks!!! Please visit <http://www.kreziesounds.com/> ! ☺☺

Architecture

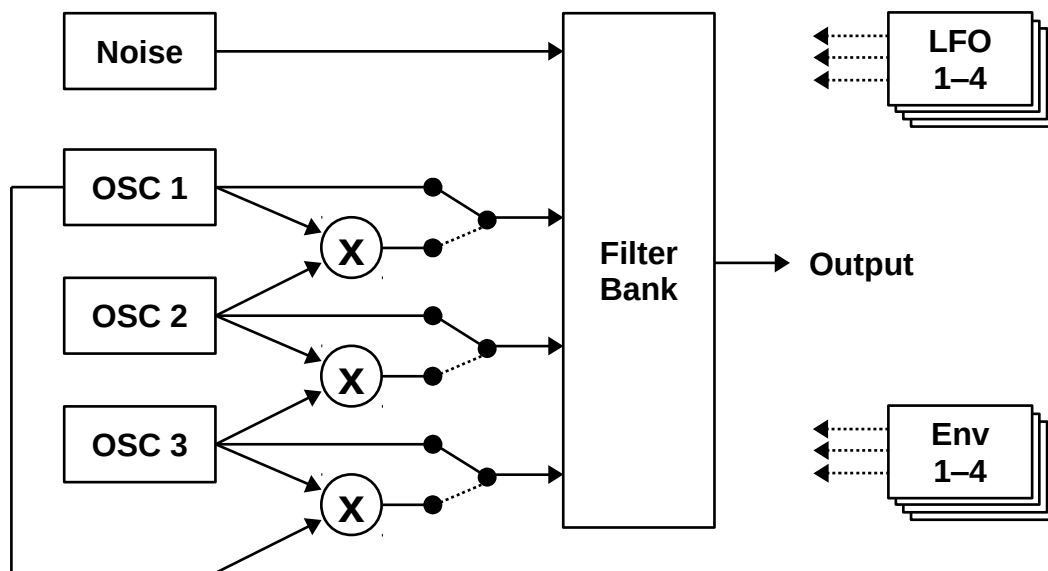

Each voice of the *qyooo* features three oscillators and one White Noise generator feeding a bank of three filters (see next section). Alternatively, the signal of an oscillator can be replaced by the Ring-modulated version of itself with another oscillator (Osc. 1 + Osc. 2, Osc. 2 + Osc. 3, or Osc.3 +Osc. 1).

Each oscillator generates five different waveforms: *Sawtooth*, *Pulse* (including Pulse Width Modulation), *Sine*, *Triangle*, and *Prime* (a waveform containing only prime number fundamentals i.e. 1, 2, 3, 5, 7, 11, 13, 17,...).

Finally, four LFOs and four envelopes are available for modulation purposes.

Filter Bank

The heart of the *qyooo* is the Filter Bank consisting of three individual filters. Each filter mode can be set to *Lowpass*, *Lowpass-x* (a distorted version as known from the *Kern VST*), *Bandpass*, *Highpass*, *Allpass*, or *Bypass*. All filters have 4 poles except for the *Lowpass-x* which has 2 poles and *Bypass* which has of course no pole at all.

The filters can be arranged in eight different ways:

Parallel 1

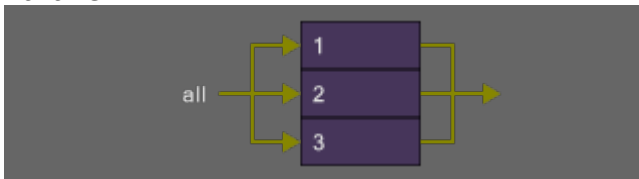

Parallel 2

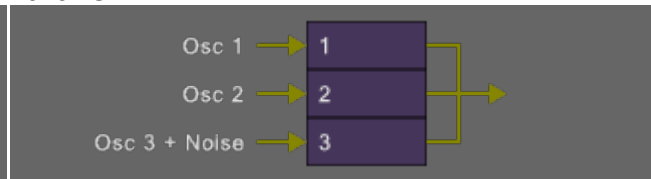

Semi-Parallel 1

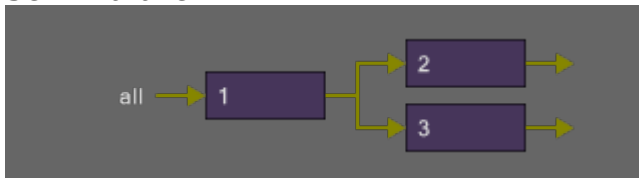

Semi-Parallel 2

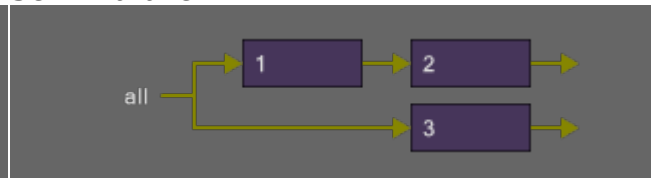

Semi-Parallel 3

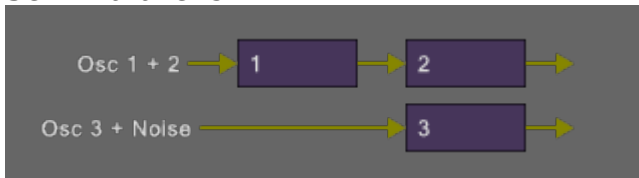

Semi-Parallel 4

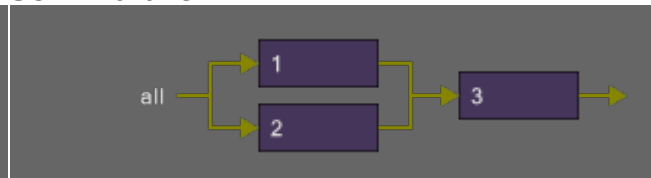

Semi-Parallel 5

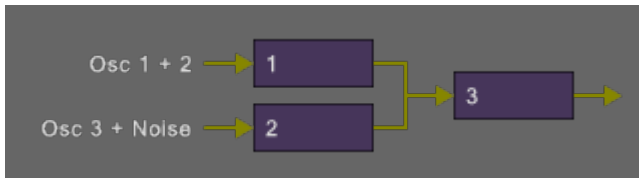

Serial

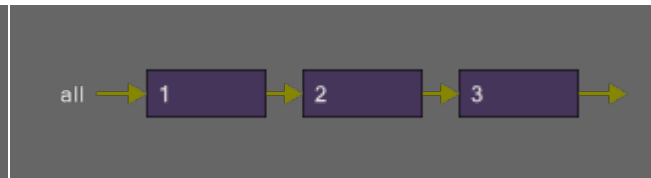

The filters are based on a (attention: buzz word!) *Zero-Delay Feedback* design and of course do provide resonance control. However, this is not the end of the story since the important part is the *Scene Morphing* used to control filter modulation... read on!

Scene Morphing

The parameters of the three filters (*Cutoff*, *Resonance*, *Volume*, and *Panorama*) are organized in four *scenes*: A, B, C, and D. Filter modulation is provided by *morphing* between these scenes. This means that you can continuously move from one setting for all filters (a scene) to a totally different one (another scene) – in two dimensions!

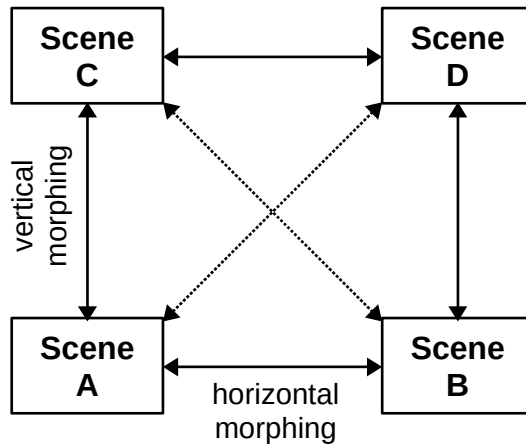

In each direction (horizontal and vertical), three different modulation sources are available for Scene Morphing. Combined with the many filter modes and arrangements, this results in a huge variety of possibilities starting from simple frequency or resonance (!) modulation to panorama control and format morphing.



To visualize the effect of the morphing, the *qyooo* features a small monitor with a green "blip" displaying the current morph state of the voice that was triggered last.

Scene Editing

It can get quite tedious to edit all the filter parameters of the four scenes. The main panel of the qyooo organizes the scenes in tabs showing only one scene at a time.



However, you can always >CLICK FOR DETAILS< which opens a modal dialog where you can edit all four scenes at the same time.



Furthermore, there are some utility and context menus for copying parameters or whole scenes to other filters/scenes.

Scene Menus

On top of each scene one finds the *Preset* menu which presets the filter parameters of a scene to some specific values i.e. vowel formants. This especially makes sense if one of the *Parallel* filter arrangements is selected.

The *Util* menu provides commands to copy all the parameters of the selected scene to another scene.

Parameter Context Menu

A right click on a filter parameter opens the *Parameter Context* menu. Here you can copy the selected parameter to one of the other filters of the scene or of a different scene. It is also possible to copy all parameters of the selected filter to another filter of the same scene.

Chorus

The Chorus can be switched on or off. Furthermore it is possible to set the speed rates of the two triangle-shaped LFOs modulating the Chorus as well as the modulation depth.

Modulation Sources

Many of the *qyooo*'s parameters can be modulated by various modulation sources. Sources that produce a control signal of positive values only (including zero) are called *unipolar* while sources producing either positive or negative values are called *bipolar*. The following table lists the available modulation sources and their polarity.

Source	Polarity	Description
<i>Off</i>	unipolar	constant value 0
<i>On</i>	unipolar	constant value 1
<i>LFO1+ to LFO4+</i>	unipolar	output of LFO1 to 4 ranging from 0 to 1
<i>Env1 to Env 4</i>	unipolar	output of envelope 1 to 4 ranging from 0 to 1
<i>Velo</i>	unipolar	MIDI note velocity
<i>Note+</i>	unipolar	MIDI note value
<i>Pbnd+</i>	unipolar	MIDI pitch bend wheel (value at center position is 0.5)
<i>Wheel</i>	unipolar	MIDI modulation wheel
<i>LFO1 to LFO 4</i>	bipolar	output of LFO1 to 4 ranging from -1 to 1
<i>Note</i>	bipolar	MIDI note (value at C4 is 0)
<i>PBend</i>	bipolar	MIDI pitch bend wheel (value at center position is 0)

LFO and Envelopes

Each of the four LFOs offers five waveforms: *Sine*, *Triangle*, *Square*, *Sawtooth*, and *S/H* (random); the speed rate ranges from 0 to 100 Hz. It is also possible to sync the LFOs to the host tempo and to reset the waveform start each time a key is pressed ("Retrigger"). Last not least the effective amount of the LFO output can be modulated by any other modulation source. This way you can control the LFO depth by the Modulation Wheel, create a delayed vibrato etc.

The four envelopes are full-blown ADSR generators offering a *Single Trigger* mode (known from the Minimoog and other synthesizers) which prevents them to be restarted when playing *legato* – of course this only makes sense in monophonic mode i.e. when the *Voices* parameter is set to 1.

Performance Controls

Program Menu

If you know my other VSTs then there will be no surprises: To select one of the 64 patches just click on the program number, and edit its' name by clicking in the text field.

MIDI Learn

Every parameter of the *qyooo* can be controlled by one MIDI controller. If you want to change the assignment of MIDI controller (CC; *MIDI Control Change*) to *qyooo* parameter the *MIDI Learn* function comes in quite handy: Just click the *MIDI Learn* button on the *qyooo*'s control panel (caption turns red) and wiggle both the MIDI controller and the parameter you want to assign (you can abort *MIDI Learn* by clicking the red button again). To save the controller assignments use "Save Configuration" in the *Options* menu (see next section).

Options Menu

When clicking on the *Options* button, a context menu opens with the following options:

Copy Program	Copy current program to internal clipboard
Paste Program	Paste internal clipboard to current program
Load Program	Load a VST program file containing a patch to the <i>qyooo</i> 's current program
Save Program	Save the <i>qyooo</i> 's current program to a VST program file
Load Bank	Load a VST bank file containing 64 patches into the <i>qyooo</i>
Save Bank	Save the <i>qyooo</i> 's 64 patches to a VST bank file
Init Program	Initialize the current program
Reload Configuration	Reload the <i>qyooo</i> 's configuration file (see section <i>The qyooo.ini Configuration File</i>)
Save Configuration	Saves the <i>qyooo</i> 's configuration file (see section <i>The qyooo.ini Configuration File</i>)
Select Startup Bank	Select the VST bank file that should always be loaded when the <i>Qyooo</i> is started
Load Startup Bank	Load the Startup VST bank file; can also be used to check what the current Startup bank is
Check Online for Update	When connected to the Internet, this function will check if a newer version of the <i>qyooo</i> is available at fullbucket.de
Visit fullbucket.de	Open fullbucket.de in your standard browser

Note: If the *qy000* DLL and the *qy000.ini* configuration file are located in a “protected” Windows folder (for example somewhere under “C:\Program Files\...”) then it may not be possible to save the configuration. In this case it is strongly recommended to use a `VstPlugins` directory that lies “outside” the protected folder.

The qyooo.ini Configuration File

The *qyooo* is able to read some settings from a configuration file (*qyooo.ini*) located in the same directory as the *qyooo* VST DLL (*qyooo.dll* or *qyooo64.dll*) itself. After you have edited this INI file in a text editor, you have to reload it using the *Reload Configuration* command from the *Options* menu (see section *Performance Controls*).

Skinning Support

The *qyooo* features some very rudimentary skinning support. Within the INI file, each of the bitmaps used in the UI can be replaced by specifying the full path to an alternative bitmap file; bitmaps that you don't want to replace can be set to default (see example below), or left out of the INI file completely.

```
[Editor]
Bitmap_Back = C:\myCoolSkins\flashy.png
Bitmap_Light = C:\myCoolSkins\nerdy.png
Bitmap_Knob = default
Bitmap_HandleV = default
Bitmap_HandleH = default
...
```

Important: The replacing graphics need to have the same size and control placement to work correctly. Also knob/button/slider graphics need to have the exact same size and number of frames to work correctly. It is not possible to alter the placement of controls, as that is handled by code in the plug-in.

MIDI Control Change Messages

All parameters of the *qyooo* can be controlled by MIDI controllers, or more precise: Each MIDI controller (except *Modulation Wheel* and *Sustain Pedal*) can control one of the *qyooo*'s parameters. The mapping is defined in the *qyooo.ini* for example like this:

```
[MIDI Control]
CC7 = 2 # Volume
CC71 = 50 # horizontal Scene Morphing
CC74 = 51 # vertical Scene Morphing
...
```

The syntax is straight forward:

```
CC<controller number> = <parameter ID>
```

Given the above example, controller 71 directly controls the *X-Morphing* parameter, controller 74 the *Y-Morphing* etc. As you can see, comments are introduced by the Pound sign (#); they are here just for description purposes and completely optional.

The *parameter ID* of one of the *qyooo*'s parameters is given in the section *Parameters* below. Note that the *controller number* can run from 0 to 119, with the exception of 1 (*Modulation Wheel*) and 64 (*Sustain Pedal*); the latter two are simply ignored.

Of course, instead of editing the controller/parameter assignments in *qyooo.ini* with a text editor it is much easier to use the *MIDI Learn* function and save the configuration (see sections *MIDI Learn* and *Options Menu* above).

Parameters

Global

parameter	ID	description
<i>Version</i>	0	Plug-in version (reserved)
<i>Voices</i>	1	Number of voices (polyphony) in steps from 1 to 64
<i>Volume</i>	2	Master volume
<i>Master Tune</i>	3	Master tune
<i>Portamento</i>	4	Portamento time
<i>Velocity</i>	5	Velocity amount
<i>Pitch Bend</i>	6	Pitch Bend range (in notes)

Oscillator 1

parameter	ID	description
<i>Volume</i>	7	Volume
<i>Shift</i>	8	Transpose (in notes)
<i>Tune</i>	9	Tuning
<i>Waveform</i>	10	Waveform (<i>Sawtooth, Pulse, Sine, Triangle, Prime</i>)
<i>Ring</i>	11	Ring Modulation on/off
<i>PW</i>	12	Pulse Width (<i>Pulse</i> waveform only)
<i>PWM</i>	13	Pulse Width Modulation (<i>Pulse</i> waveform only)
<i>PWM Source</i>	14	Source for PWM (unipolar – <i>Pulse</i> waveform only)
<i>FM 1</i>	15	Frequency Modulation 1 depth
<i>FM 1 Source</i>	16	Source for FM 1
<i>FM 2</i>	17	Frequency Modulation 2 depth
<i>FM 2 Source</i>	18	Source for FM 2

Oscillator 2

Same as Oscillator 1; parameter IDs range from 19 to 30.

Oscillator 3

Same as Oscillator 1; parameter IDs range from 31 to 42.

Noise

parameter	ID	description
<i>Volume</i>	43	Volume
<i>AM</i>	44	Amplitude Modulation depth
<i>AM Source</i>	45	Source for AM (unipolar)

Filter Bank

parameter	ID	description
<i>Arrangement</i>	46	Filter arrangement; see section <i>Filter Bank</i>
<i>Filter 1 Mode</i>	47	Mode of Filter 1 (<i>LP, LP-x, BP, HP, AP, Bypass</i>)
<i>Filter 2 Mode</i>	48	Mode of Filter 2 (<i>LP, LP-x, BP, HP, AP, Bypass</i>)
<i>Filter 3 Mode</i>	49	Mode of Filter 3 (<i>LP, LP-x, BP, HP, AP, Bypass</i>)

Scene Morphing

parameter	ID	description
<i>X-Morphing</i>	50	Horizontal Scene Morphing; see section <i>Scene Morphing</i>
<i>Y-Morphing</i>	51	Vertical Scene Morphing; see section <i>Scene Morphing</i>
<i>X-Mod 1</i>	52	X-Morphing 1 Modulation depth
<i>X-Mod 1 Src.</i>	53	Source for X-Morphing 1 Modulation
<i>X-Mod 2</i>	54	X-Morphing 2 Modulation depth
<i>X-Mod 2 Src.</i>	55	Source for X-Morphing 2 Modulation
<i>X-Mod 3</i>	56	X-Morphing 3 Modulation depth
<i>X-Mod 3 Src.</i>	57	Source for X-Morphing 3 Modulation
<i>Y-Mod 1</i>	58	Y-Morphing 1 Modulation depth
<i>Y-Mod 1 Src.</i>	59	Source for Y-Morphing 1 Modulation
<i>Y-Mod 2</i>	60	Y-Morphing 2 Modulation depth
<i>Y-Mod 2 Src.</i>	61	Source for Y-Morphing 2 Modulation
<i>Y-Mod 3</i>	62	Y-Morphing 3 Modulation depth
<i>Y-Mod 3 Src.</i>	63	Source for Y-Morphing 3 Modulation

Scene A

parameter	ID	description
<i>Frequency 1</i>	64	Filter 1: Cutoff frequency
<i>Resonance 1</i>	65	Filter 1: Resonance
<i>Volume 1</i>	66	Filter 1: Volume
<i>Panorama 1</i>	67	Filter 1: Stereo panorama (not applicable for <i>Semi-Parallel</i> or <i>Serial</i> filter arrangements)
<i>Frequency 2</i>	68	Filter 2: Cutoff frequency
<i>Resonance 2</i>	69	Filter 2: Resonance
<i>Volume 2</i>	70	Filter 2: Volume
<i>Panorama 2</i>	71	Filter 2: Stereo panorama (not applicable for filter arrangements <i>Semi-Parallel 4</i> , <i>Semi-Parallel 5</i> and <i>Serial</i>)
<i>Frequency 3</i>	72	Filter 3: Cutoff frequency
<i>Resonance 3</i>	73	Filter 3: Resonance
<i>Volume 3</i>	74	Filter 3: Volume
<i>Panorama 3</i>	75	Filter 3: Stereo panorama (applicable for all arrangements)

Scene B

Same as Scene A; parameter IDs range from 76 to 87.

Scene C

Same as Scene A; parameter IDs range from 88 to 89.

Scene D

Same as Scene A; parameter IDs range from 90 to 111.

LFO 1

parameter	ID	description
<i>Wave</i>	112	Waveform (<i>Sine</i> , <i>Triangle</i> , <i>Square</i> , <i>Sawtooth</i> , <i>S/H</i>)
<i>Sync</i>	113	Synchronization to host tempo
<i>Retrigger</i>	114	Restart wave when key is pressed
<i>Speed</i>	115	LFO speed (0 to 100 Hertz or note length)
<i>AM</i>	116	LFO Modulation depth
<i>AM Source</i>	117	Source for LFO Modulation

LFO 2

Same as LFO 1; parameter IDs range from 118 to 123.

LFO 3

Same as LFO 1; parameter IDs range from 124 to 129.

LFO 4

Same as LFO 1; parameter IDs range from 130 to 135.

Envelope 1

parameter	ID	description
<i>Trigger</i>	136	Trigger mode (<i>Multiple</i> or <i>Single</i>)
<i>Attack</i>	137	Attack time of envelope
<i>Decay</i>	138	Decay time of envelope
<i>Sustain</i>	139	Sustain level of envelope
<i>Release</i>	140	Release time of envelope

Envelope 2

Same as Envelope 1; parameter IDs range from 141 to 145.

Envelope 3

Same as Envelope 1; parameter IDs range from 146 to 150.

Envelope 4

Same as Envelope 1; parameter IDs range from 151 to 155.

Chorus

parameter	ID	description
<i>Chorus</i>	156	Chorus on/off
<i>LFO 1 Rate</i>	157	Rate of first Chorus LFO
<i>LFO 2 Rate</i>	158	Rate of second Chorus LFO
<i>Amount</i>	159	Depth of Chorus modulation

Frequently Asked Questions

How do I install the qyooo (32 bit version)?

Just copy the files `qyooo.dll` and `qyooo.ini` from the ZIP archive you have downloaded to your system's or favorite DAW's VST plug-in folder. Your DAW should automatically register the *qyooo* VST plug-in the next time you start it.

How do I install the qyooo (64 bit version)?

Just copy the files `qyooo64.dll` and `qyooo.ini` from the ZIP archive you have downloaded to your system's or favorite DAW's VST plug-in folder. Your DAW should automatically register the *qyooo* VST plug-in the next time you start it.

Note: You may have to remove any existing (32 bit) `qyooo.dll` from your VST plug-in folder or else your DAW may screw the versions up...

How do I install the qyooo on the V-Machine?

1. Make sure that you have installed the latest V-Machine firmware and VFX software (available from www.smproaudio.com). The *qyooo* is known to work with version 2.0.20101204. :-)
2. I will not take any responsibility if the following install procedure does not work for you, corrupts or damages your V-Machine, or bores you! :-P
I do have a V-Machine and tested the *qyooo* against it. Have faith! ;-)
3. Export the files `qyooo.dll`, `qyooo.ini`, and `qyooo.vfxwizard` from the ZIP archive to a temporary folder on your PC/Mac. Run the VFX software and import the `qyooo.dll` plug-in from this folder; select the `qyooo.vfxwizard` under the *Wizard File* option (this will ensure that the `qyooo.ini` is copied to the V-Machine as well).
4. Create a preset for your V-Machine using the *qyooo* and you're done!

What is the VST plug-in ID of the qyooo?

The ID is `fbqy`.

How can I decrease the blooo's CPU load?

Always try this:

- If you don't need one of the three oscillators, set its volume to 0.
- If you don't need one of the three filters, set its mode to *Bypass*.

Whenever it does not degrade the *sound* you need, try this:

- Reduce polyphony, i.e. the number of voices.
- Turn of tempo-synchronization of the LFOs.

I spent a lot of time customizing the MIDI controller/parameter assignments. Can I save these assignments?

Yes, by using "Save Configuration" in the *Options* menu (see section *Options Menu*).

Why doesn't the configuration file (qyooo.ini) get saved?

Maybe you have placed the *qyooo* files *qyooo.dll/qyooo64.dll* and *qyooo.ini* into a "protected" folder somewhere under "C:\Program Files\..."? In this case you should use a *VstPlugins* directory that lies "outside" the protected folder (also see section *Options Menu*).

I twiddle the panorama of Filter 1/2 but nothing is happening!

Check if you have selected a *Semi-Parallel* or *Serial* filter arrangement: A filter that sends its output signal to the input of another filter cannot be positioned in the stereo field since filter inputs are always processed in mono.

How do I know if a new version of the qyooo is available?

When connected to the Internet, open the Options menu (see section *Options Menu*) by clicking the disk icon and select the entry "Check Online for Updates". If a new version of the *qyooo* is available on fullbucket.de the respective information will be shown in a message box.

Again another stupid plug-in name with to many "o"s in it...!?

Indeed. Be grateful that I spare you the German umlauts.